

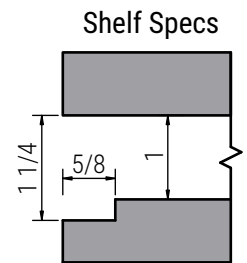

# EZ-LOC 1210-10 Specs

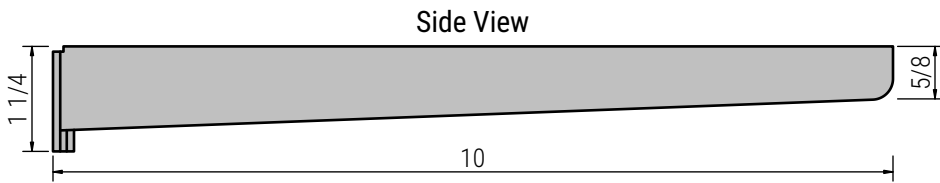
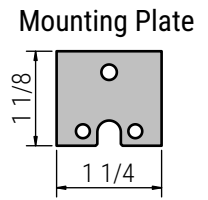
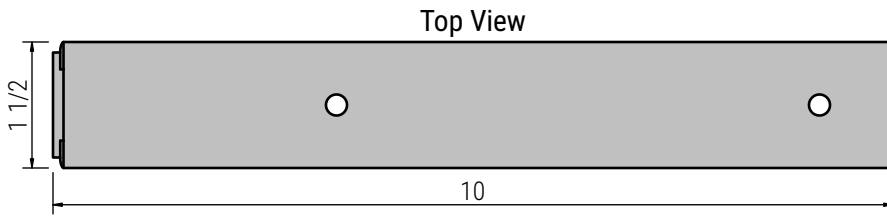
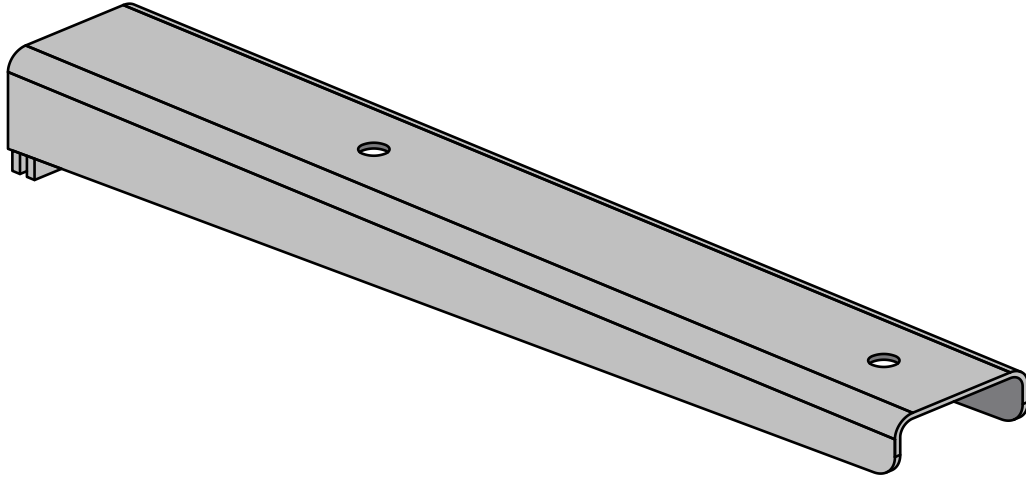

## Weight Limit [per bracket]

Wood Stud: 60 lb

## Deflection [wood stud application]

50 lb: 1/16