

INSTRUCTION MANUAL

for Installing

RFID ELECTRONIC LOCK TO INVISIDOOOR

ID.LOCK-PSLOCK



Instruction Manual for RFID Electronic Lock for Invisidoor®

Hardware Included:

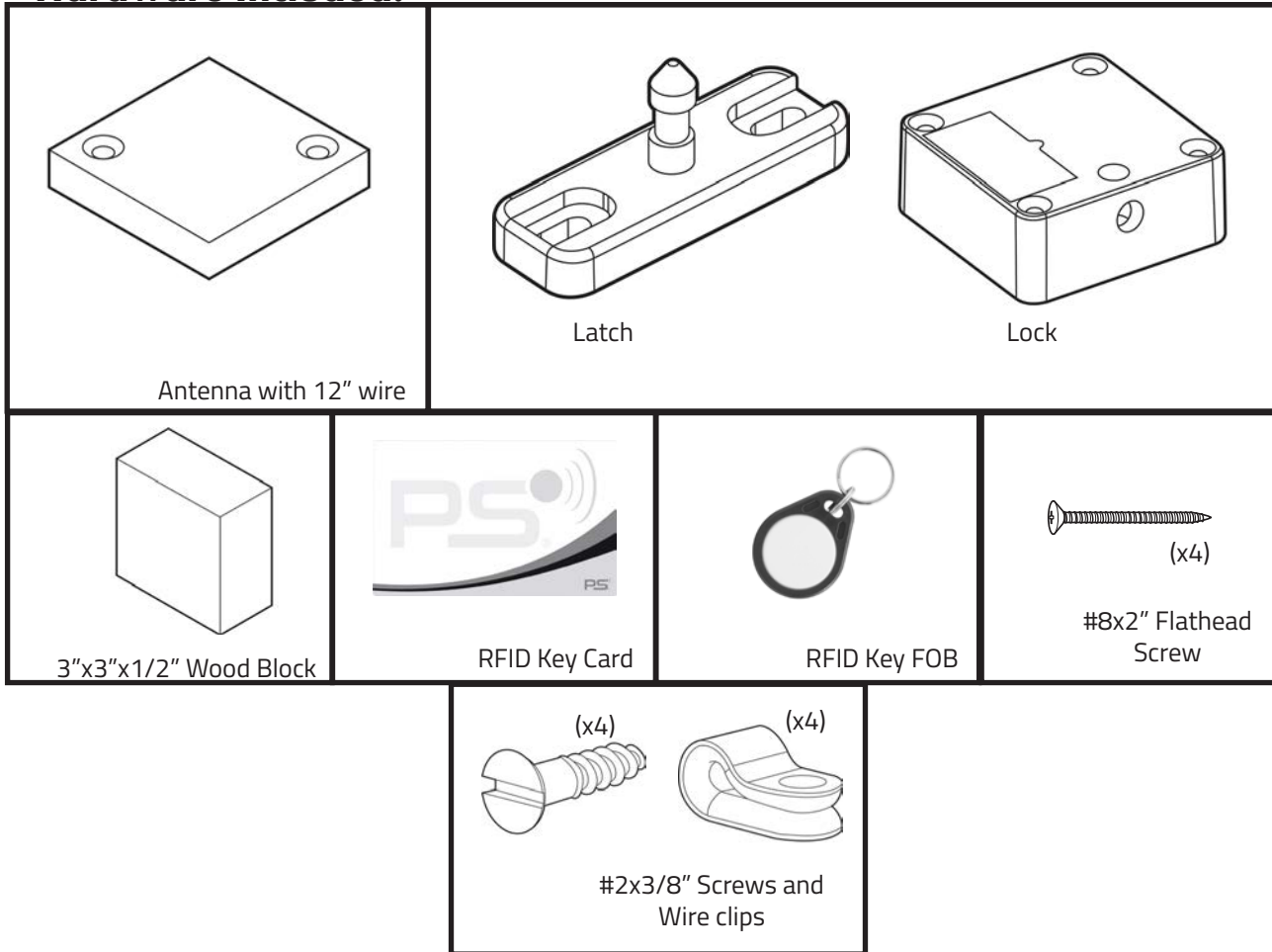

Installation Tools Needed:

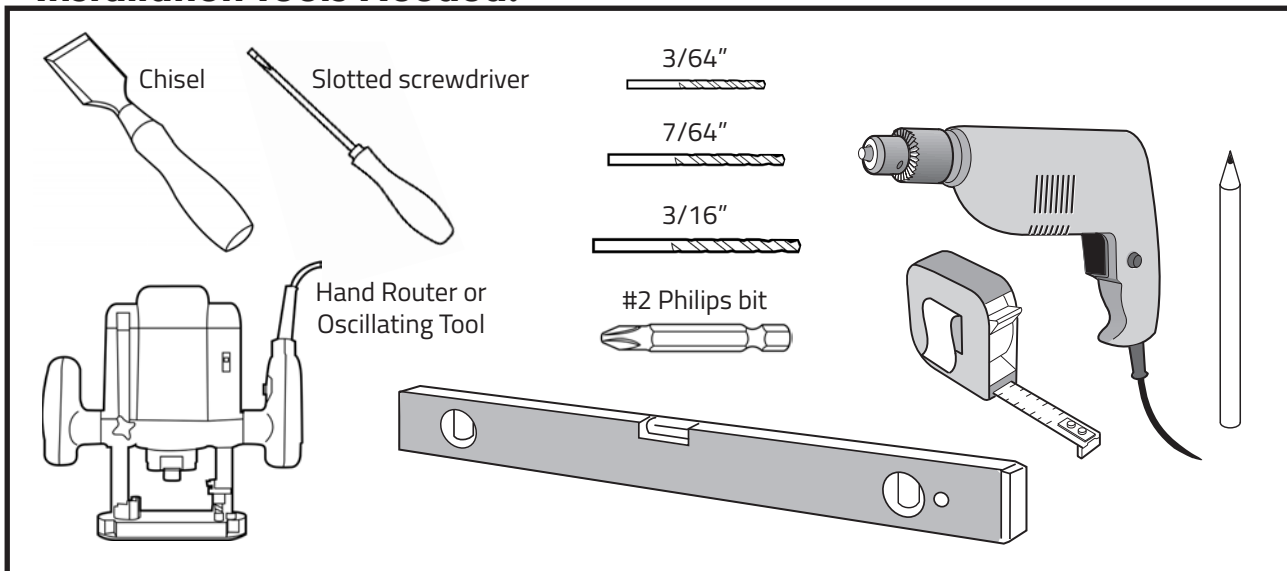

Below is the In-swing Installation steps. If you have an Out-swing application, please proceed to the Out-swing Installation Steps on Pg. 5

Application Notes (please read prior to starting installation):

- A. Invisidoor must be installed completely following provided Instructions.
- B. Make sure spacing from the inside of the jamb face to the side of the Invisidoor cabinet is **1⁵/₈"** on the side opposite the hinges where the lock will be located. Refer to Invisidoor installation instructions to adjust hinges to achieve this gap.
- C. Instructions are the same whether it is a left or right swing door.

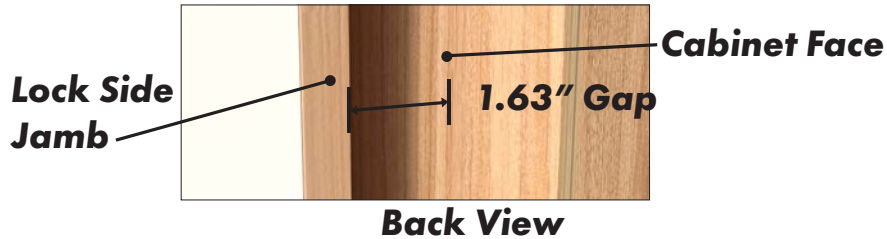

In-swing Installation Steps

1. Locate the door jamb opposite the hinge side. This side is where the latch will install to the jamb. Instructions will refer to this location viewing from the inside of the door (see figure 1).
2. Measure up from the floor 38" along the side of the cabinet (see figure 1). Mark the cabinet side with a pencil at this height to establish the mounting height for the latch (see figure 3, red line).
3. Drill four (4) 3/16" through holes in diamond pattern centered on the supplied wood block (see figure 2). Chisel a V-notch as shown to allow antenna wire to run out from under the lock.
4. Mark a center line on the block face along the same edge as the chiseled notch.
5. Hold the block against the cabinet face with the marked lines aligned and the block .31" from the back of the cabinet (see figure 3). Use the power drill with square bit to drive in the first #8x2" flathead screw to install the wood block to the cabinet. Use a level to make sure the block is level while installing the remaining #8x2" flathead screws to finish installation of the block (see figure 3).

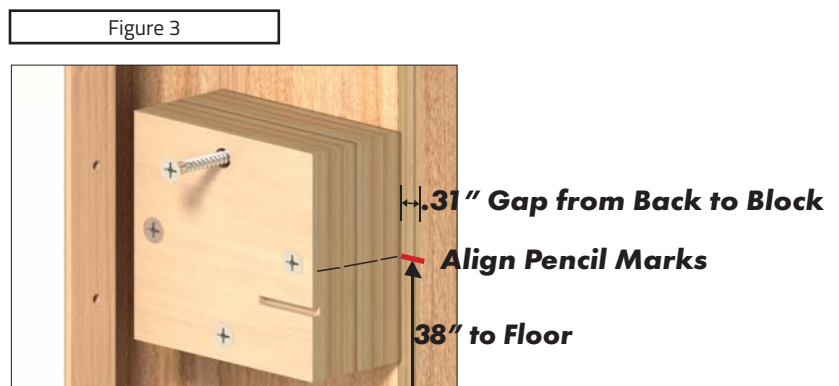
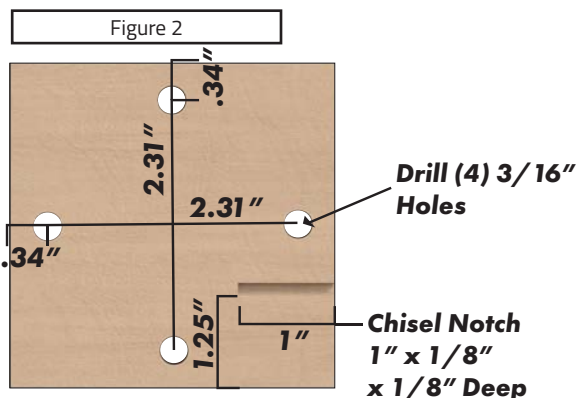

6. Attach antenna plug to back side of lock. Use either port, making sure two cords from plug are oriented towards the center (see figure 4). Install lock battery, you should hear it beep.
7. Test fit lock to latch to ensure mounting location for lock and latch are set properly for proper lock and latch engagement.

Figure 4

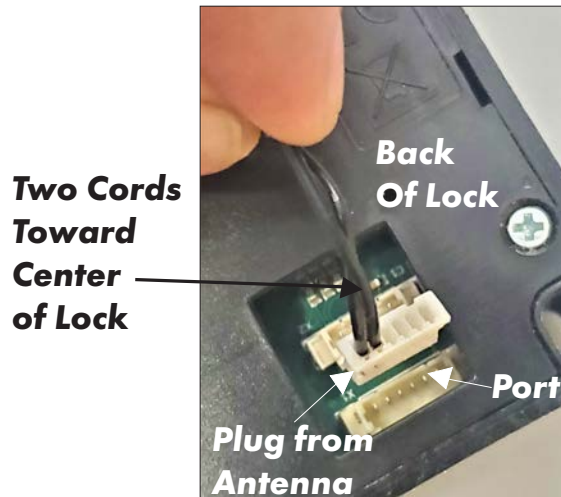

Key is used to lock and unlock. Make sure to test lock and latch in unlocked setting.

8. When testing lock engagement with key, make sure lock is centered on pin when engaged in latch to allow for tolerance movement when door will engage to lock. Back lock off latch slightly to allow for some forward and back tolerance. When lock location is determined, mark lock location with pencil to install latch to wood block with screws.
9. Transfer holes from lock. Use 1/8" pilot drill to start holes drill 1/8" down.
10. Use four (4) M4x35mm flathead wood screws to install lock to wood block. Make sure to run antenna cord out chiseled notch. Make sure lock is level to latch when driving in screws (see figure 5).

Figure 5

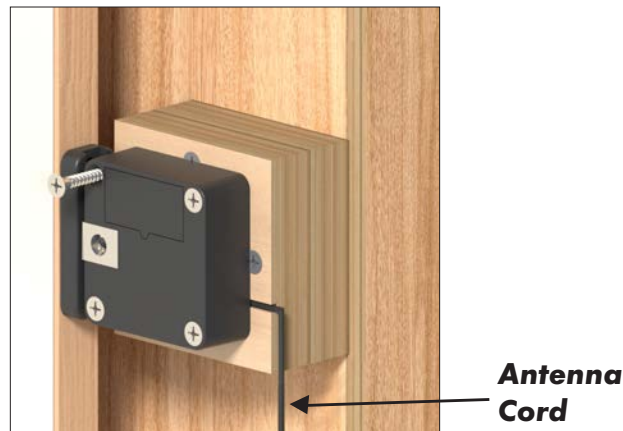

11. Use supplied M3x20mm screws to install antenna block to cabinet (*see figure 6*). Use $\frac{3}{32}$ " drill bit to create pilot holes, but make sure depth is limited to $\frac{1}{4}$ " deep MAX. Antenna can be placed anywhere above the lock on the back or side of the cabinet within wire reach. Choose a location that will be easy to find from the front of the Invisidoor. Use supplied wire clips to manage antenna wire to remove any slack and bundle wire that is not used (*see figure 7*).

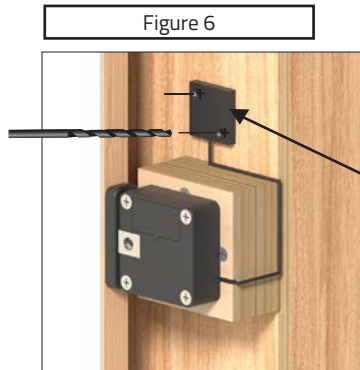

Figure 6

Note: To secure wire clips to wall, use $\frac{3}{64}$ " pilot bit and #1 slotted bit.

Antenna block

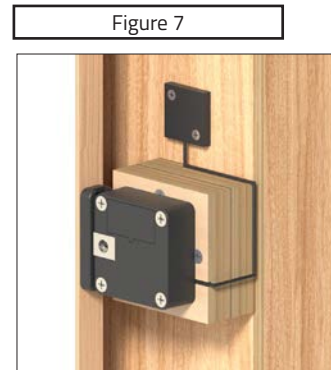

Figure 7

12. With a pencil, mark two holes on the door through the latch. Drill pilot holes for mounting the latch to the jamb using a $\frac{1}{8}$ " bit, $\frac{1}{2}$ " deep (*see figure 8*).
13. Use the (2) M4x16mm" wood screws to install latch to the jamb (*see figure 9*).

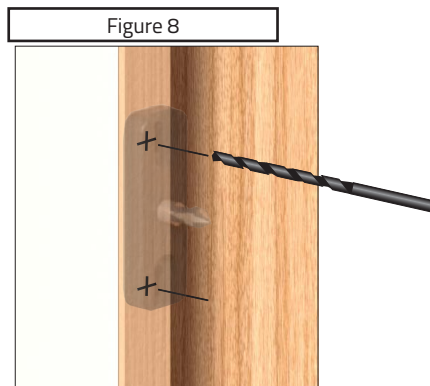

Figure 8

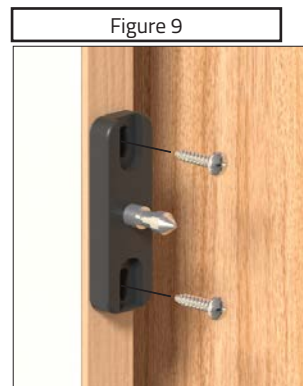

Figure 9

14. With the lock installation complete, use the RFID card or FOB to test the activation of the lock from outside the Invisidoor through the cabinet. Hold card or FOB over location opposite the antenna location on the back side of the cabinet to activate lock. Check to make sure there is even clearance when lock engages to latch. You can loosen latch screws to adjust latch location slightly to help improve engagement if needed.

*Once Invisidoor is loaded with weight (i.e. books etc.),
Latch location might need to be adjusted.*

Outswing Installation Steps Start Next Page

If RFID Card and/or FOB is lost, please call (602) 315-0151 or email usa@pslocks.com for replacements. Use supplied programming card and instructions to reprogram cards.

Application Notes (please read prior to starting installation):

- A. Invisidoor must be installed completely following provided instructions.
- B. Instructions are the same whether it is a left- or right-swing door.
- C. Do not mount lock or latch directly to drywall surfaces. Recommended application is in solid wood with predrilled holes for wood screws. Blocking may be required.

Out-swing Installation Steps

1. Locate the door jamb opposite the hinge side. This side is where the latch will install in the jamb. Instructions will refer to this location viewing towards the Jamb with the Invisidoor ajar (see figure 1).
2. Measure up from the floor 36" along the jamb face (see figure 2). Mark the jamb face with a pencil at this height to establish the mounting height for the bottom of the lock.
3. Place the template (page 9) at the marked height. Make sure the latch outline is flush with the outside jamb edge. The latch will mount to the back of the trim panel.
4. Pull the Invisidoor closed with the attached trim to confirm latch sits flush to trim panel (see Figure 2).
5. Open Invisidoor and use the pencil to outline the lock from template. This line will be used as the perimeter cut using the router or oscillating tool for notching the jamb out for the lock (see figure 2).



Before you cut, confirm there is Solid Wood or a Stud to fasten the Lock flush to the back of the Jamb. If there isn't wood directly behind the Jamb, consider cutting the Jamb only 3/8" deep.

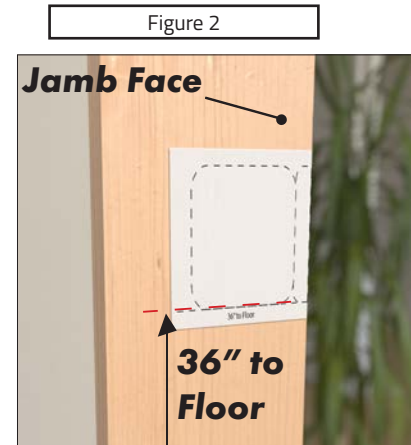

- Use a hand router and set the depth of $\frac{1}{4}$ ". Mill through the jamb in 3 steps, a $\frac{1}{4}$ " at a time following inside the lines drawn from the lock and latch profile on the jamb. Finish cut to $\frac{3}{4}$ " deep out to expose stud underneath. The Invisidoor with attached trim panel will conceal this notch. This could also be accomplished with an oscillating tool (see figure 3).

Figure 3



Figure 4

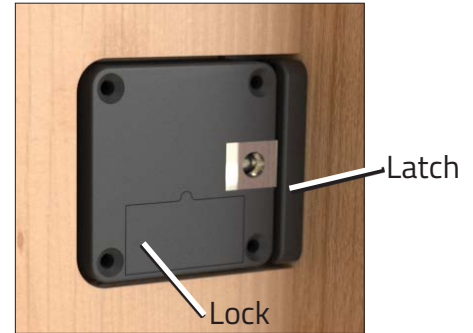

- Test fit the lock and latch in the pocket to confirm both items fit. Shut the Invisidoor with the trim panel shutting flush with the back of the latch without interference (see figure 4).

- Place the antenna above or below the lock location along the leading outside edge of the jamb where you prefer to access the lock with the RFID Card or FOB. Mark profile and depth of the antenna block flush with the jamb face (see figure 5).
- Make sure the antenna is concealed by trim when the door is closed.
- Using a hand router, oscillating tool, or chisel, notch into the jamb edge and drywall, cut to the depth of the Antenna Block using the marks made on the previous step (see figure 5).
- Install antenna into cutout using supplied M3x20mm screws. Use $1\frac{3}{32}$ " Pilot drill - down $\frac{1}{4}$ ". Make sure antenna wire is clear of pinching, and run out flush along the jamb face for wire management to the lock (see figure 5).

Figure 5

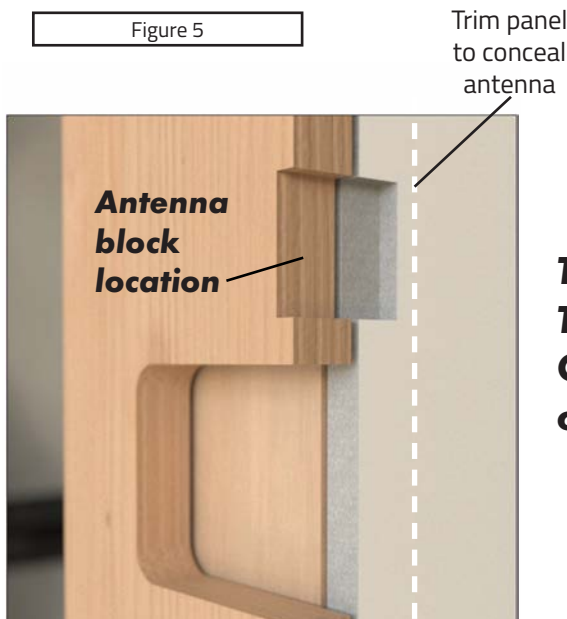
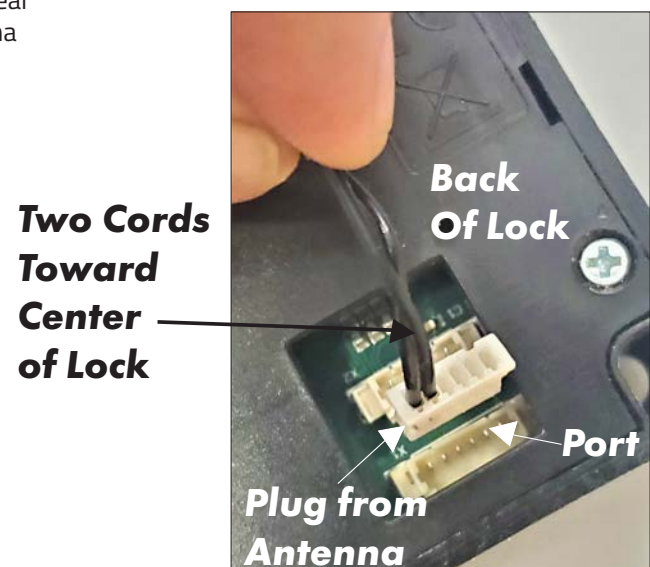

Figure 6



12. Attach antenna plug to back side of lock. Use either port, making sure two cords from plug are oriented towards the center (see figure 6).
13. Install the lock battery. You should hear it beep.
14. As you prepare to install Lock with attached antenna cord, make sure there is clearance underneath the lock for the wire to chase out of the cutout. This can be accomplished either by notching the bottom of the pocket with a V-cut where the wire runs out the back or by using washers between the lock and the stud when installing the screws (see figure 7).
15. Once lock is installed in place, use four (4) M4x35mm wood screws to attach the latch and shut Invisidoor with trim panel against latch. Mark with the pencil where the latch is located on the trim panel (see figure 8).

Figure 7

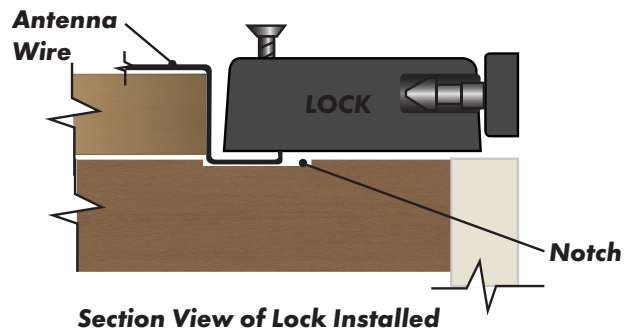
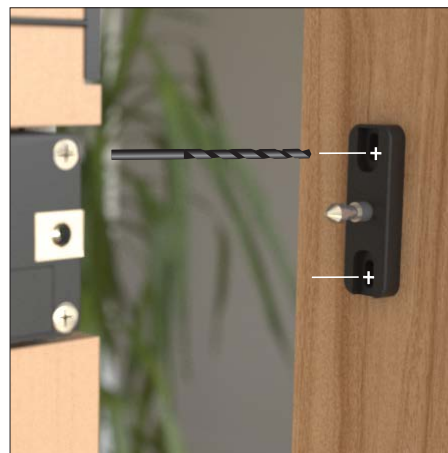

Figure 8



Figure 9



16. Using the markings when the Invisidoor is closed, open the Invisidoor and mark hole locations for pilot drilling for two M4x16mm screws. Pilot drill using 1/8" bit in 12", making sure not to drill through (see figure 9).
17. Install latch using supplied screws and test latch engagement in lock making sure latch pin is engaging center to the lock. You can loosen latch screws to adjust latch location slightly to help improve engagement if needed.
18. Install latch using supplied M4x16mm screws and test latch engagement in lock making sure latch pin is engaging center to the lock. You can loosen latch screws to adjust latch location slightly to help improve engagement if needed.

Once Invisidoor is loaded with weight (i.e. books etc.), Latch location might need to be adjusted.

Hardware Dimensions

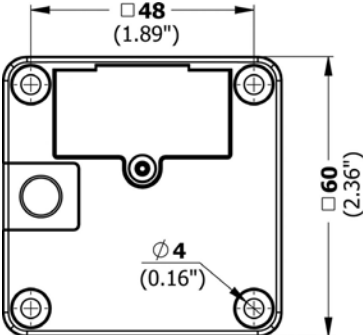

Electronic Lock

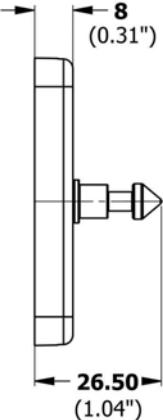
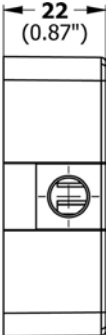

Latch

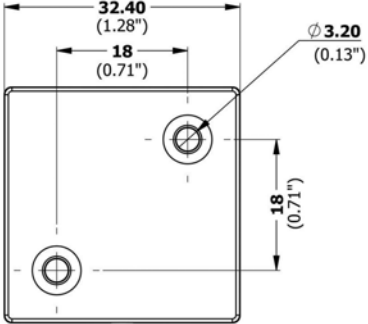
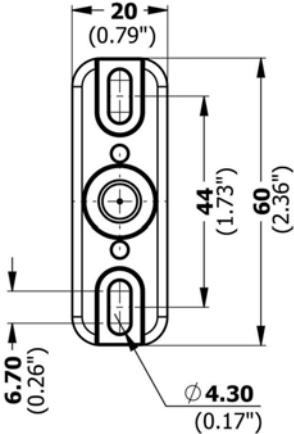

External Antenna

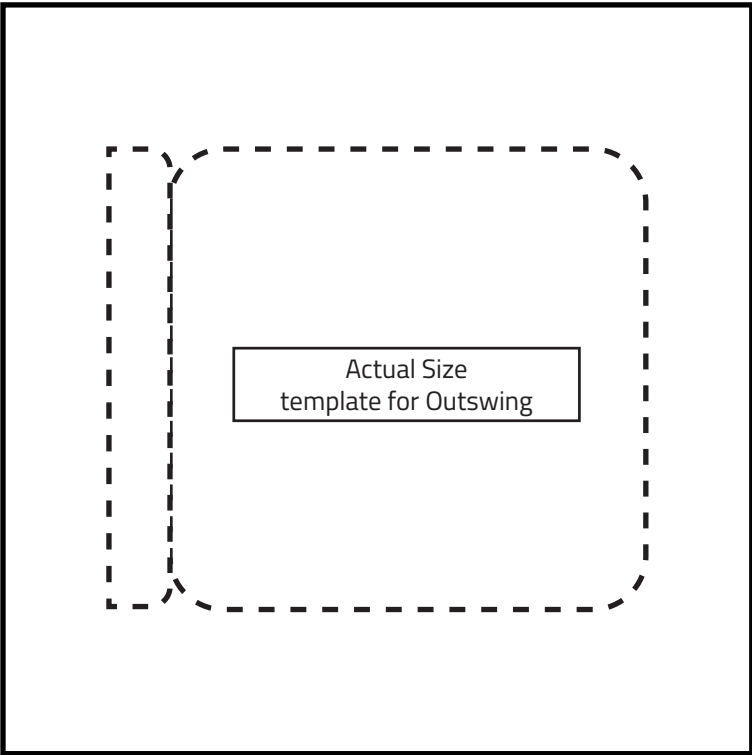

Invisidoor Application Images



